

## APOLLO MAGNA® WORKTOPS INSTALLATION INSTRUCTIONS

**apollo**<sup>®</sup>  
LUXURY FOR LESS  
**magna**  
The 6mm thick solid surface

### Apollo Magna® Worktops

Installing Apollo Magna® Worktops is easy. If, for example, you have previously fitted a similar product then these simple to follow instructions will enable you to successfully install Apollo Magna®.

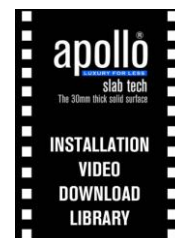
Please read these instructions thoroughly before commencing installation. Ensure that you read, understand and follow Health & Safety Guidelines carefully.

Comprehensive video clips demonstrating installation and general Care & Maintenance are available at [www.sheridan-uk.com](http://www.sheridan-uk.com)



## About Apollo Magna® Worktops

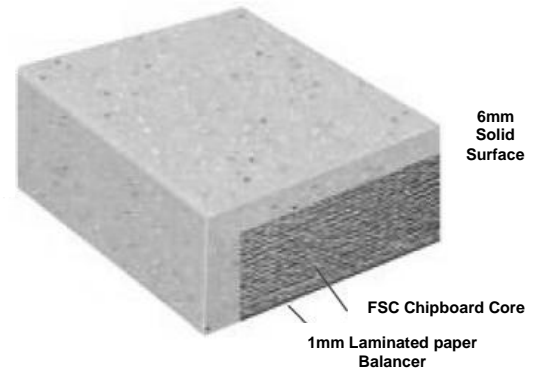
- 6mm thick homogeneous solid surface bonded to an FSC Grade solid chipboard core with a laminated paper balancer and moisture resistant membrane.
- Comprehensive range of 56mm, 34mm and 19mm overall worktop thicknesses.
- 6mm thick solid surface material is used for the downturned front edge and both return edges, Breakfast bars have a downturned edge on both of the long edges.
- NSF Certified products.
- Non porous and easily maintained
- Excellent impact resistance
- Scratches and marks can be sanded out
- Easy to install for any recognised kitchen installer or even DIY specialist!
- Tested to FIRA industry standards.
- Materials backed by a 10 year manufacturer's limited warranty – for further details see the web site [www.sheridan-uk.com](http://www.sheridan-uk.com).
- To View Installation Videos, and to see or download Installation Guides and Care & Maintenance Guides, see the web site [www.sheridan-uk.com](http://www.sheridan-uk.com) and on the home page, scroll down and click on the icon "Installation Video download Library and follow the instructions – see image on the right.



# Apollo Magna® Product Specification

## Apollo Magna® Solid Surface Worktops

- Available in a variety of styles and sizes:
  - 6mm thick solid surface bonded to an FSC Chipboard Core with a laminated paper moisture resistant balancer on the underside.
  - Easily Trimmed to size and can be re-finished to suit.
  - Easily Installed with inconspicuous joints for a seamless appearance
  - Curved End Corner, Sink and Drainer Groove Jigs available.



## Health & Safety

### PRODUCT WEIGHT

Note that this product is significantly heavier than most other types of worktop – 30mm Magna worktops weigh 20.5 Kg per square metre: 34mm Magna worktops weigh 28.7 Kg per square metre, 56mm Magna worktops weigh 43.7 Kg per square metre!

### ON SITE ADVICE

- Ensure that worktops are clean and free of dust, dirt etc.
- Use polythene sheets and dust covers to protect all appropriate areas.
- Work outside on worktops wherever possible, to limit amount of dust inside building.
- Use Trestles and a Workbench to fully support the Worktops.
- Seal doorways of adjoining rooms when working indoors.
- Screen off the cutting area with plastic sheeting.

### HEALTH & SAFETY ADVICE

- Ensure adequate ventilation to enable dust and fumes to escape when working indoors.
- Wear Heavy duty work gloves when handling worktops.
- Wear a Dust Mask when polishing or cutting.
- Wear Ear Defenders when working with tools and machinery.
- Wear Safety Spectacles when cutting or grinding.
- Secure work pieces. Use clamps to hold down work pieces when practical.
- Keep children and visitors away from the work area.
- Always lift or carry worktops with at least 2 capable people – see the yellow “Caution Heavy” Labels on the edge and top of the worktops for guidance.

## Handling & Storage

### Handling

- Always carry your worktops on their edge, they should be lifted and handled by at least 2 people – please check the yellow label on the worktops for this information. This will prevent the worktops from bowing and cracking under their own weight.
- Handle the worktops as little as possible, they are very heavy and the edges can be easily damaged by their own weight.

### Storage

- Prepare the storage area for your delivery, it should be a dry room at normal room temperature (18 - 20°C), away from direct heat sources and damp floors or walls.
- Store worktops flat on at least 4 equal thickness support bearers (see above) – keeping the worktop vertical on edge, lower one edge carefully onto the bearers and then let down the other edge flat onto the bearers.
- Acclimatise the worktops to their installed room 24 – 48 hours before installation – move the worktops into or next to the installation site and unpack, store flat on the floor as before but with dividing bearers between each worktop to allow good air circulation.



- Avoid storage in an outhouse, shed, damp garage or any room that is not weather proof, with an unstable temperature, or in a new or unoccupied property.
- Avoid Storage vertically, on edge or directly on the floor, this will cause the worktops to bow and distort.
- Allow any room that is freshly plastered or with any residual damp or is unheated to fully dry out and reach room temperature before any installation is started.

# Designing Your Worktop Layout

Careful planning is the key to successful installation. If possible begin planning with a pre-site survey.

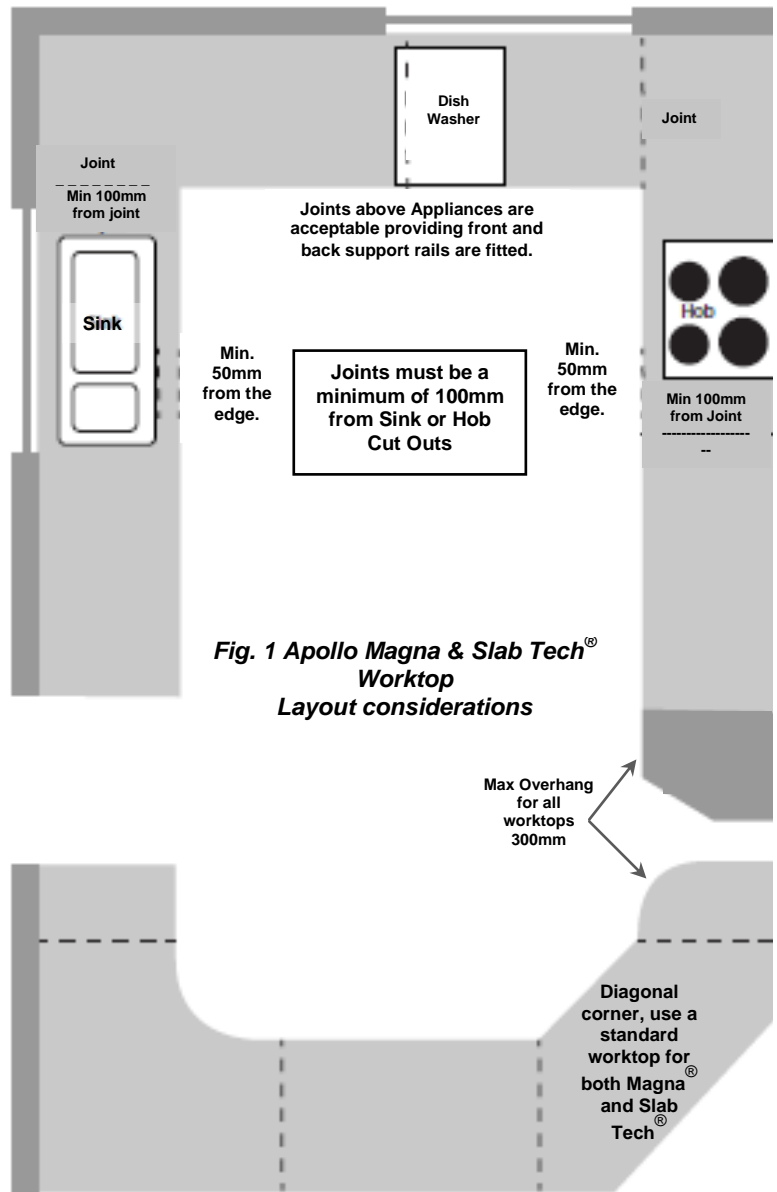
When designing your Worktop Layout, you should start by establishing where the Sink and other appliances will be installed and then the corner from where you will start to install each of the worktops, from this you can plan where the joints between each of your worktops should be – please see Fig. 1 for a common kitchen layout.

## • When planning your worktop layout:

- Ensure joints do not fall on or within 100mm of cutouts.
- Plan how you are going to fit each top and the resulting joints, avoid both joints in the same direction in a “U” shaped layout.
- Ensure cutouts are at least 50mm from worktop edge
- Joints in worktops should fall on a carcass end not in the middle, this gives added support to a joint
- Each worktop requires an expansion clearance (to the wall) of 1mm for every linear metre of worksurface (i.e. 3mm for a 3 metre length)
- Magna® worktops should not be planned to have overhangs greater than 300mm.
- Allow at least 120mm between heated Cut Outs.
- Allow at least 50mm behind an electric hob or 120mm behind a gas hob to the front of any Splashback that is over 100mm in height.
- All worktops over gaps between floor cabinets (i.e. for appliances) greater than 600mm long, must be supported with suitable wall battens to add support and stop bending under load
- All worktops over spaces unsupported by the floor cabinets greater than 600mm long (i.e. some Sink and Corner Cabinet designs) must have additional support along the walls using suitable wall battens
- Where fitting over two adjacent appliances is unavoidable, always fit an End Support Panel between the two appliances – see Fig 2.
- Corner joints should never be mitered into the corner.

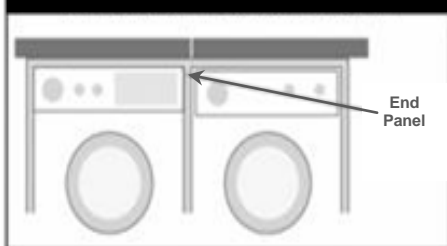
## Magna® Worktop Joints

- Always use Masons Mitre (also called Butt & Scribe) jointed corners – see Fig. 12.
- The Loose Tongues required for these joints are supplied with the 3Mx600mm Worktops – enough for 2 joints.

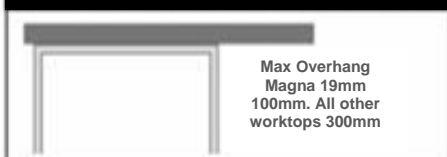


**Fig. 1 Apollo Magna & Slab Tech® Worktop Layout considerations**

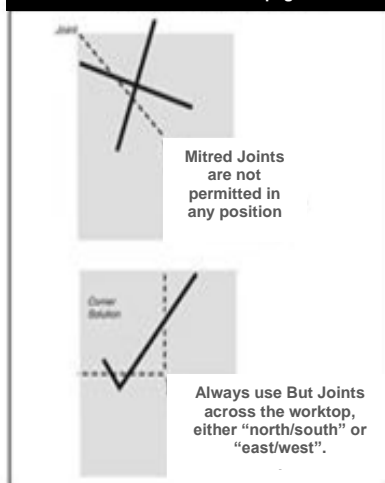
Try to avoid planning two appliances together. If unavoidable, fit an intermediate end panel



Unsupported overhangs should never exceed 300mm (100mm for Magna 19mm worktops)

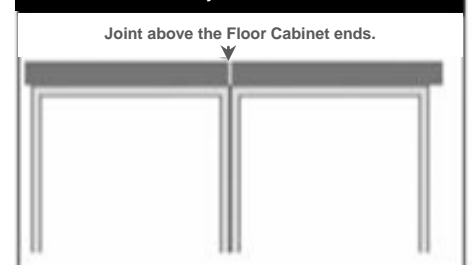


Corner Joints should never be mitred. Always use a corner solution as page 6



**Fig. 2**

Where possible, for correct support, plan all joints to be situated directly above floor cabinet ends



# Before Installation

For future reference, peel off the product labels and attach to this Installation Guide on page 9, you will need the information on the labels to support any Customer Service or Warranty queries.

- Unpack immediately before fitting and check all components for damage and colour match before commencing installation. This can be easily done by butting the components together and wiping the adjacent areas with a damp cloth.
- These Worktops are manufactured to strict tolerances but some variation in colour will occur with this type of material. Should there be an unacceptable colour variance, please contact your store before commencing installation. Claims for colour variation cannot be made after installation.
- Level all Floor Cabinets and End Panels front to back, along the length and around corners before any measuring or installation.
- Check the site conditions and where required, fit support battens to the walls along all gaps between floor cabinets, unsupported lengths greater than 600mm (i.e. behind Corner and Double Floor cabinets) and along the walls in spaces for appliances between floor cabinets.
- Ensure that you have the correct Colour Coordinated Glue for all joints and edging –supplied separately in 100ml Glue Cartridges, sufficient for 2 full worktop joints or 12 metres of Upstand. If in doubt, check with your store.
- Ensure that you have sufficient sheets of Moisture and Heat Resistant aluminium membrane (supplied in the Installation Kit) to be fitted to the worktop underside above any appliance (i.e. Dishwasher or Washing Machine) or moisture and/or heat emitting objects (i.e. radiators). Claims cannot be made for swollen, cracked or distorted worktops above appliances that have not had this membrane fitted.
- Ensure that you have sufficient Moisture and Heat Resistant Aluminium Tape (supplied in the Installation Kit) to be fitted according to the instructions to the edges of worktop cut-outs for Hobs and other heat generation appliances. Claims cannot be made for swollen, cracked or distorted worktops around appliance cut-outs that have not had this tape fitted.
- N.B. This Tape must bridge the joint line between the bottom edge of the Downturn (front edge) and the bottom face of the white coated Chipboard core material.

## Tools and Materials Required

### GENERAL TOOLS – not supplied by Sheridan Fabrications

- Random orbital sander plus dust extraction equipment.
- Hand router: minimum of 1850W with ½"/12.7mm Colet size.
- 30mm Guide Bush
- 12.7mm x 40mm TCT Router Cutter.
- Straight Trimming Router Cutter (with a guide bearing).
- Drainer groove cutter – if required to make drainer grooves.
- Wide Chisel (minimum 1"/25mm)
- Electric saw – with fine tooth blades.
- Power planer.
- Silicon Gun.
- Hot Melt Gun.
- "G" Clamps.
- Softwood Blocks
- Biscuit Joint Router Cutter

Various Jigs are available to help install Sink & Hob Cutouts and Drainer Grooves to suit your installation

### SOLID SURFACE® INSTALLATION KIT - CONTENTS\*

- Sandpaper 100, 150, 220grit
- Abrasive Pads
- Self Adhesive Aluminium Heat and Moisture membrane Foil
- Heat Reflective Tape
- Fixing Pack of Screws, Washers & Brackets

### Not supplied by Sheridan Fabrications

- Silicone Sealant (High Modulus) for sealing edges to walls and cabinets.
- Rotobond 2000 MS Polymer Sealant - recommended for fitting Stainless Steel under mounted sinks.

## Cutting to Size

Mask off the section of worktop to be cut and mark the cutline on the masking tape.

Cut the blank to size squaring ends using router fitted with sharp, double-fluted tungsten carbide straight cutter and a straight edge (Fig. 3).

*When routing through the thickness of the worktop, to ensure a clean cut and avoid "chatter marks", make 3 to 5 passes along the cut increasing the depth of cut by 6/7mm with each pass until the complete thickness is cut through.*

*For instance, this will take 3 passes for 20mm and 5 passes for 30mm thick Slab Tech worktops.*

Curved corners can be achieved using the router as above and the Curved End Corner Jig.

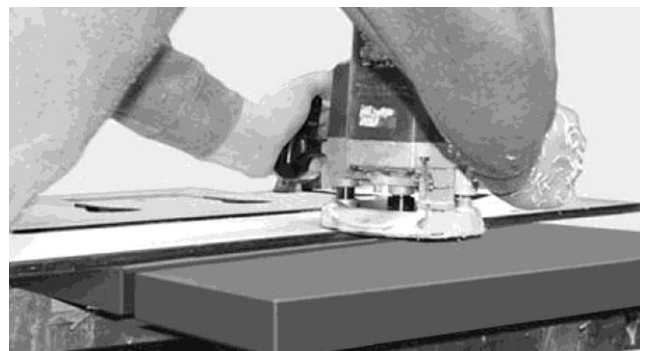


Fig. 3: Cutting to size using a Router

# Fitting End Edging Strips - Straight and Curved

## Fitting a Straight Edging Strip: – see Fig. 4

These Apollo Magna® Worktops have finished downturns on both ends of the worktops and when cut to size they can usually be fitted with any cut end being concealed against a wall. However when this is not possible a 6mm thick solid surface Edging Strip is available to finish the cut to size end of a worktop.

The Edging Strip is designed to be fitted onto the chipboard core of the worktop underneath the 6mm thick top surface, this preserves a seamless top surface and enables the fitted edge to have an unobtrusive joint.

Prepare the worktop by first cutting to the required overall length plus a trimming allowance of 2mm. Now turn the worktop upside down. Using a hand router, cut back the chipboard of the cut end by 8mm leaving space for the Edging Strip and a 2mm overhang. **Do not remove the front downturn or the top Solid Surface.** Then increase the depth of the cut to remove 0.5mm of the underside of the top surface leaving 5.5mm thickness, this will enable the Edging Strip to bond to the top surface.

With a chisel, remove the chipboard “fillet” (left by the router cutter) behind the front downturn to allow space for the edging strip to fit right up the back face of the front downturn – see top right of Fig. 5.

Clean the face and edges of the Edging Strip to be used with the alcohol wipes supplied, clean the prepared cut back faces of the worktop end in the same way, allow to dry. Keep the work area dust free to avoid contamination of the glue joint.

Using the correct coloured Magna® Glue Cartridge, apply continuous beads of glue to the chipboard core and the inner faces of the solid surface top and front downturn. Without touching the face and edges to be glued, position the Edging Strip and squeeze into place ensuring that a continuous bead of glue flows out of the joint line and that the edging strip is pressed up to the back face of the front downturn.

Clamp in position and allow the glue to cure to a hard consistency, this usually takes 30 to 40 minutes dependent upon the ambient temperature.

Using a hand router fitted with a straight trimming cutter (fitted with a guide bearing, see Fig. 5a.); remove the 2mm overhung edges of the solid surface material.

If required to match the factory finish on the front edges of the worktop, this can be completed where required using a profile cutter (with bearing) having a 3mm radius.

When all trimming and profiling is finalised, sanding and finishing can be completed following the instructions later in this guide in the section **“Finishing the Joints”**.

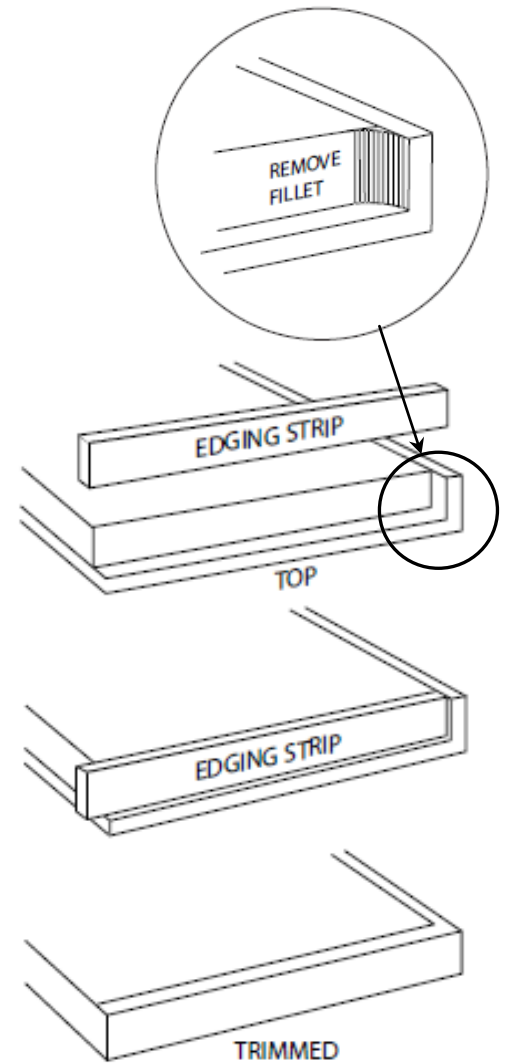


Fig. 4 Fitting the Edging Strip



Fig. 5 Straight Trimming Cutter with guide bearing

## Fitting Curved Edging Strip: see Figs 6, 7 & 8

The ends of these Apollo Magna® Worktops can also be shaped into curves to suit Curved Floor Cabinets. For this purpose, a preformed 6mm solid surface Curved Edging Strip is available to finish the cut to size and shaped end of a worktop, a Router Jig is also available specifically to enable the installer to produce a worktop with a shaped curved end to fit the Curved Edging Strip.

As for the straight Edging Strip above, the Curved Edging Strip is designed to be fitted onto the chipboard core of the worktop underneath the 6mm thick top surface, it is fitted in much the same way and this preserves a seamless top surface and enables the fitted edge to have an unobtrusive joint.

Prepare the worktop by first cutting to the required overall length plus a trimming allowance of 2mm then turn the worktop upside down.

The Curved End Jig is designed for use with a suitable hand router (ideally for 12.7mm/ 1/2" Collets) used with a 12.7mm (1/2") straight router cutter and a 30mm guide bush. The Jig has 2 curved profiles to be used on the Bottom and Top faces of the worktop, it can be flipped over to use for Left or Right Hand curved ends, it is engraved to help identify which way up to use and how to position correctly. Start with the Bottom Face part of the jig.

Place the jig on the underside with the “Bottom Front Edge” flush with the front edge of the Top and the “Side” set back 17mm from the edge of the return end, and clamp in position.

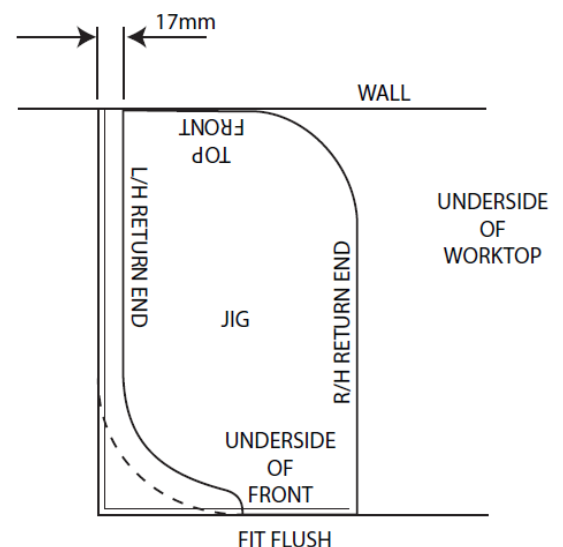
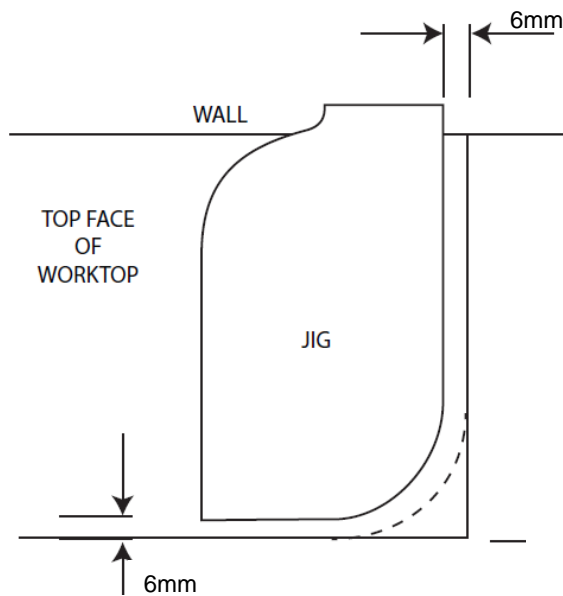


Fig.6: Positioning the Router Jig to remove the FSC Chipboard core, working from the underside of the Magna Worktop.





**Fig. 7: Positioning the Router Jig to remove the excess Solid Surface, working from the Top Face of the Magna Worktop.**

The method is to start at the step in the front edge of the jig and follow the full curve and along to the back edge of the worktop, removing the chipboard core into a curved shape set back from the front edge sufficiently to fit the 6mm thick curved edging strip.

**Do not remove the excess Top Solid Surface at this stage, see below.**

Then increase the depth of the cut to remove 0.5mm of the underside of the top Solid Surface leaving 5.5mm thickness, this will enable the Curved Edging Strip to bond to the top surface.

With a chisel, remove the chipboard "fillet" (left by the router cutter) in the start of the cut behind the front downturn to allow space for the edging strip to fit right up the edge of the front downturn and flush with it's front face.

Next, turn the worktop over to work from the top face. Position the jig on the top face with the side edge set 15mm back from the return end and the leading front edge aligned with the worktop front edge.

Set the router plunge depth to cut through the top Solid Surface material.

Again, the method is to start at the step in the front edge of the jig and follow the full curve and along to the back edge of the worktop removing the excess top material leaving space underneath against the chipboard core for the Edging Strip and a 2mm overhang along the side return end edge tapering to no overhang on the front edge.

The Curved Edging strip is supplied with extra length on the front and side edges to help it to be fitted exactly. The extra length on the front needs to be trimmed off to fit neatly into the rebate that you have created in the Front Downturn. The extra length on the side edge is trimmed off after gluing in place.

Clean the face and edges of the Edging Strip to be used with the alcohol wipes supplied, clean the prepared cut back faces of the worktop end in the same way, allow to dry. Keep the work area dust free to avoid contamination of the glue lines.

Using the correct colour matched Magna® Glue Cartridge, apply continuous beads of glue to the chipboard core and the inner faces of the solid surface top and front downturn. Without touching the face and edges to be glued, position the Edging Strip and squeeze into place ensuring that a continuous bead of glue flows out of the joint line and that the front end of the edging strip is pressed up to the inner face of the cutout in the front downturn – see the 2 middle views of fig. 7 to the right .

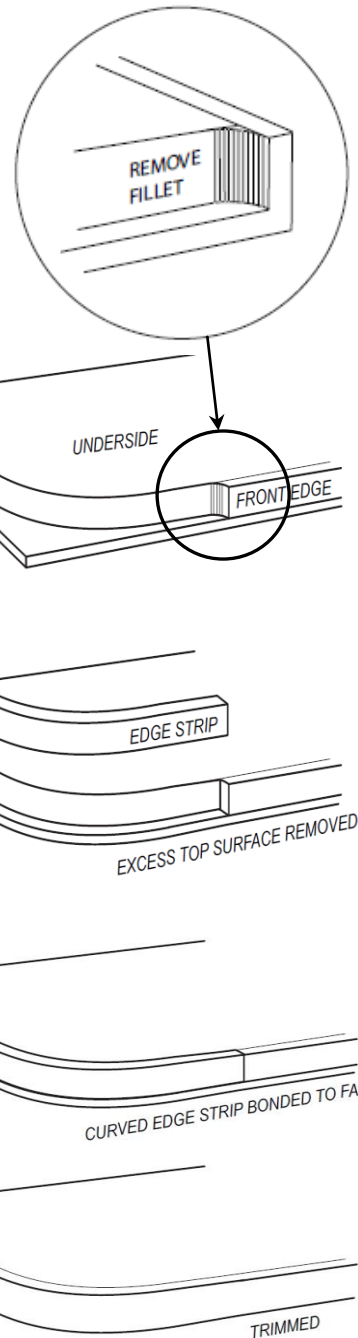
Clamp in position and allow the glue to cure to a hard consistency, this usually takes 30 to 40 minutes dependent upon the ambient temperature.

Using a hand router fitted with a straight trimming cutter (fitted with a guide bearing); remove the 2mm overhung edges of the solid surface material.

If required to match the factory finish on the front edges of the worktop, this can be completed where required using a profile cutter (with bearing) having a 3mm radius.

When all trimming and profiling is finalised, sanding and finishing can be completed following the instructions later in this guide in the section "**Finishing the Joints**".

**NOTE: This method of fitting both Straight and Curved Edging Strips is the only one supported by the 10 Year Manufacturers Limited Warranty; the use of any other method will invalidate this Warranty.**



**Fig. 8: Fitting the Curved Edging Strip**

# Scribing the Worktop to the Wall (where necessary)

The scribing process reflects the contours of uneven back walls to the worktop, allowing the correct overhang at the front of the base cabinets. If the walls are straight or there tiling is being fitted, it may not be necessary to scribe worktops to the wall.

1. Place the worktop onto the base cabinets and push up against the back wall in its intended position. Measure the worktop overhang at the front of the base cabinets; this should be 30 - 35mm. If the overhang exceeds 35mm, it may be necessary to trim sufficient material from the back of the worktop to allow it to be pushed back. If scribing is necessary, follow the instructions below.

2. Apply a strip of 50mm masking tape to the worktop surface, flush with back edge of the worktop.

3. Place a small block of wood onto the worktop surface and against the wall where the gap is the greatest. (Pull the worktop away from the wall by the thickness of this block of wood)

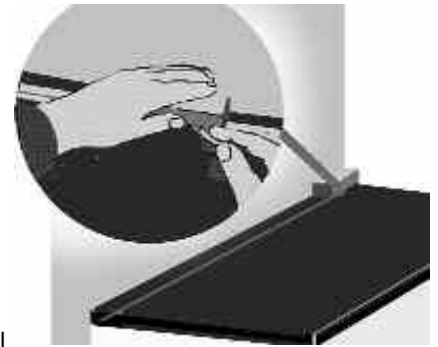
## 6. Sealing the Scribed Edges

When Scribing is complete, it is advisable to seal the exposed chipboard core against moisture ingress from the surroundings using PVA Adhesive. When fitted, the joint between all worktops and any walls should be sealed with a bead of flexible silicon sealant.

## 7. Hot Pipes

When hot pipes need to pass through the worktop, there should be a minimum clearance of 10mm between the cut-out and the pipe(s) in order to stop heat transfer from the pipes to the worktop and to comply with the warranty. In most cases the pipes will be boxed in concealing the clearance hole and stopping any damage to the worktop from spilled liquids. Even with boxing in place the edges of the cut-out must be sealed well with PVA Adhesive to stop any possible water ingress.

4. Place a pencil against the front edge of the block and slide the block and pencil along the entire length of the worktop, marking a pencil line on the masking tape as you proceed (see illustration right).



5. Using this method any deviation in the wall and any obstructions such as pipes are transferred and marked onto the masking tape on the worktop.

6. Working to the waste side of the pencil line, carefully trim away any excess worktop using a router.

# Hob & Inset Sink Cut Outs

- Follow the instructions and the template supplied with the Hob or Sink or use them to make a Jig from the Template that will enable you to make the Cut Out in the Magna® Solid Surface and the rebated Cut Out into it's underside.
- Clamp the hob or sink jig/template in correct position onto the worktop (Fig. 8). Check that corners have correct radius for the hob or sink (some sink radii are rather large) before commencing. In all cases use a minimum cutter diameter of 12mm and ensure that the minimum radius of 6mm is left inside each corner - do not remove it to leave a square corner.
- All cut-outs must be machined using a router with a 12.7mm router cutter and a 30mm guide bush. When routing through the thickness of the worktop, to ensure a clean cut and avoid "chatter marks", make 3 to 5 passes along the cut increasing the depth of cut by 6/7mm with each pass until the complete thickness is cut through.
- Remove the sharp top and bottom edges with fine sandpaper or profile the edges with a 2mm radius all round using a router.
- The edges of the exposed chipboard core of all cut-outs must be sealed well with PVA Adhesive to stop any possible water ingress.

## Hob Cut Out only: see Fig. 9 & 10

**Please Note:** The inner edge of the Cut Out must leave 6mm clearance around all sides of the hob to stop excess heat transferring into the worktop.

- Apply heat reflection tape around the entire cut out (Fig. 10), ensuring that it protrudes beyond the hob flange and is in contact with worksurface and hangs straight down, heat reflection tape is required for all hot cut outs. Apply a second piece of reflective tape to all corners to ensure adequate

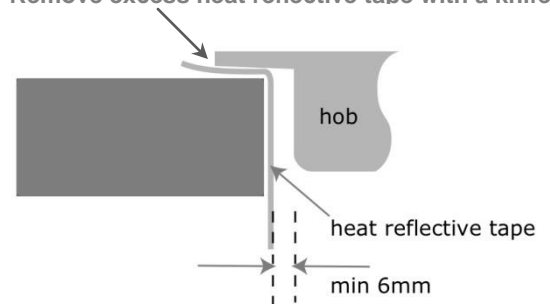
## Fitting Inset (Top Mounted) Sinks and Hobs:

- Before installing Hobs or Inset Sinks, ensure that the top face of the worktop around the cut out is thoroughly clean and dust free then degrease using the alcohol wipes (provided in the Installation kit) and allow to dry.
- Always follow the installation instructions supplied with the Sink or Hob including sealing between the Sink or Hob and the work surface.
- If there are no instructions to seal between the Sink or Hob and the Work Surface, this must be completed as follows: - Apply a continuous bead of Rotobond 2000 or suitable High Modulus Silicon sealant to the flange of the sink and press into position, ensure that the bead is squeezed out continuously all along the joint line to provide a watertight seal. Following the sink instructions tighten all of the sink clamps.



**Fig. 9 Hob/Sink template clamped in position**

Remove excess heat reflective tape with a knife



**Fig. 10 Application of heat reflective tape**

# Under Mount Sinks & Drainer Grooves

## Undermount Sink Cut Out

- Follow the instructions and the template supplied with the Hob or Sink or use them to make a Jig from the Template that will enable you to make the Cut Out in the Magna<sup>®</sup> Solid Surface and the rebated Cut Out into it's underside.
- Clamp the hob or sink jig/template in correct position onto the worktop (Fig. 8). Check that corners have correct radius for the hob or sink (some sink radii are rather large) before commencing. In all cases use a minimum radius of 6mm.
- All cut-outs must be machined using a router with a 12.7mm router cutter and a 30mm guide bush. When routing through the thickness of the worktop, to ensure a clean cut and avoid "chatter marks", make 3 to 5 passes along the cut increasing the depth of cut by 6/7mm with each pass until the complete thickness is cut through.
- Remove the sharp top and bottom edges with fine sandpaper or profile the edges with a 2mm radius all round using a router.

## Fitting Under mounted Sinks to a Cut Out:

**Please Note:** If Drainer Grooves are required, they should be made at this stage, please refer to the later section "Installing Drainer Grooves" before continuing.

Using the instructions above, cut the opening in the top surface for the under mounted Sink using the Template supplied with the sink. The underside of the sink cut out is made next, ensuring that the worktop is fully supported and that the working surface is dust and debris free, turn it over to be face down to work on the underside.

- As before, accurately clamp the correct jig into position onto the underside of the worktop ensuring that the jig handing corresponds to the Cut-out handing.
- Using a hand router carefully remove the excess chipboard from the back face in 2or 3 passes, the final pass should remove 0.5mm of the underside of the solid surface material, leaving 5.5mm thickness of solid surface material around the sink Cut-out material to provide a fresh clean and flat face to fit the sink flange into, this is needed for the silicon sealant to fully seal the sink to the worktop
- Confirm that the fit is correct by placing the inverted sink (s) in position without any sealant; adjust the machined "rebated" edges to suit.
- The edges of the exposed chipboard core of all cut-outs must be sealed well with PVA Adhesive to stop any possible water ingress.
- Before installing under mounted Sinks, ensure that the underside of the exposed solid surface face of the worktop around the cut out is thoroughly clean and dust free then degrease using the alcohol wipes (provided in the Installation kit) and allow to dry.
- Apply a continuous bead of Rotobond 2000 or suitable High Modulus Silicon sealant to the flange of the sink and press into position, ensure that the bead is squeezed out continuously all along the joint line along both the inner and outer edge to provide a watertight seal. Following the sink instructions, fit (using 12mm screws) and tighten the sink clamps in the correct order and then remove excess sealant and smooth the bead then leave without moving to allow the sealant to set.
- Apply a length of the Aluminium Reflective Tape along this front edge and in any position that is exposed to moisture (i.e. in front of a dishwasher), This Tape must bridge the joint line between the bottom edge of the Downturn (front edge) and the bottom face of the white coated Chipboard core material.
- Note: If a Wasted disposer is to be fitted to an Under mount Sink, the sink will need additional independent support such that the weight of the Waste Disposer is not supported by the Under mount Sink. Additional extra support is also required such that the weight is not supported by the worktop if a Ceramic Sink is fitted.

## Installing Drainer Grooves:

- A Jig is available for the cutting of Drainer Grooves. The jig is designed for up to 6 grooves but you can install the quantity required to suit your sink , either using part of the jig for fewer grooves or using it in another position to add more grooves.
- Place the Jig in the position that suits your needs – it is 600mm deep (the same depth as your worktop) – if you line up the front and back edges the grooves will be positioned central to the worktop. You can also vary the length of the grooves to extend them further from the sink bowl by moving the Jig either closer or further away from the sink along the worktop.
- Clamp the Jig firmly in the desired position.
- Use a hand router fitted with a 30mm guide bush and a 25mm diameter "Water Channel" cutter, set the plunge depth to 2mm – **do not cut deeper than 2mm.**
- Starting at the end away from the sink, plunge the router and machine smoothly along the Jig to create the drainer groove – do not force the router and try to finish in one pass along each groove – this will provide a smooth finish that is much easier to sand and finish.
- Check the Jig position and clamps and repeat for all of the remaining grooves that you require.
- Follow the finishing instructions to hand sand and finish the grooves as described below.



## Hand Sanding the Drainer Grooves.

- Using the sandpaper pads supplied (wrapped in a loop around a spare Hot Melt Glue cartridge) in the correct order of 100 grit, 150 grit and finally 220grit, sand along the grooves.
- Complete the finishing process using the supplied abrasive pads in the correct order of Maroon, Grey and finally the white Abrasive Pad.
- The white abrasive pad should be used on a dust free surface that has been wetted with the Stone guard cleaner spray.

**Fig. 11 Drainer Groove Jig clamped in position and ready to be routed.**

## Tap Holes

- Tap holes are drilled with a hole saw fitted with an appropriate sized cutter with fine teeth, then remove the sharp top and bottom and hole edges with fine sand paper. The edges of the exposed chipboard core of the tap hole must be sealed well with PVA Adhesive to stop any possible water ingress.



# Preparing the Joint

## Joint Type

Apollo Magna® Worktops should only be joined by means of a Masons Mitre Joint (also called a Scribed Butt Joint) supported by a Loose Tongue (also called a Cleat) inserted into a groove in the two faces of the joint.

## Male and Female Masons Mitres - see Figs. 12 and 13.

A Masons Mitre Joint is made up of Male profile in one worktop and a Female profile in the other worktop to be joined to it, the male and female profiles are joined together using a Loose Tongue inserted into a groove in both faces of the joint.

Using the specified coloured adhesive an unobtrusive and visually seamless joint can easily be achieved with basic laminate worktop jointing experience.

## Male and Female Masons Mitres – see Fig. 12

With a standard worktop jig, prepare male and female masons mitres on the required mating surfaces of the 2 worktops to be jointed, using a router fitted with a standard straight Tungsten Carbide cutter and guide bush as specified for the jig being used.

It is recommended that the Chipboard Core surfaces of all joints are lightly hand sanded using a Sanding Block to remove any loose or proud chipboard Particles before sealing well against water ingress with PVA Adhesive – allow to dry before the next stage, but wipe off any PVA from the solid surface edges with a damp cloth.

## Loose Tongue – see Fig 13

Using a 6mm groove cutter, router a 6mm wide 16-17mm deep groove into each face of the male and female joint, cut this groove immediately below the bottom edge of the solid surface top material where it is bonded to the chipboard core.

This groove should be along almost the whole length of the joint, finishing just short of the back face of the front edge solid surface material – roughly 8mm from the front face.

Each joint requires a Loose Tongue to fill the length of the joint; these are made from 6mm solid surface and are supplied in the 3M x 600mm Apollo® Magna Worktops

## Worktop Joint: see Figs. 14 & 15

The key to making a good seamless joint is to ensure that both sides of the joint are perfectly mirror matched. Assemble the joint dry (without adhesive) and check that the seams are parallel, with no gaps showing, and that the two surfaces are not stepped when brought together (redress to square edge with hand router if necessary).

Apply timber blocks to either side of the seam using hot melt glue, and use G-clamps to bring them together (n.b. Do not use hot melt glue on the end grain of the timber blocks as this makes the blocks difficult to remove). Alternatively, suction cups can be used to bring the joint together.

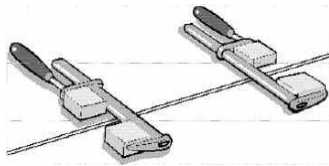


Fig. 14 Timber blocks and clamps

If it is unavoidable that a joint falls over a void or over the centre of a floor cabinet, you must provide extra support under the joint line, i.e. an additional batten fitted into the floor cabinet between the front and back rail.

Before bonding the joints, it is important to ensure that the seam is free from any contamination. Immediately before applying and glue, both faces of the joint that have been skimmed and checked as above must be cleaned with an alcohol wipe (included in the Installation Kit) and allowed to dry. Do not touch the cleaned areas except with glue.



Fig.12: Masons Mitre Jig shown on Left and joint faces shown below

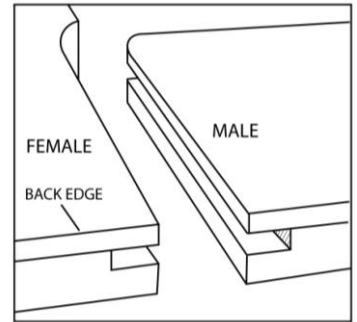


Fig. 13

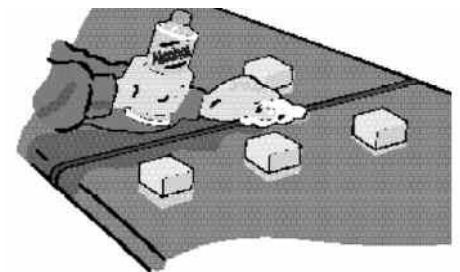
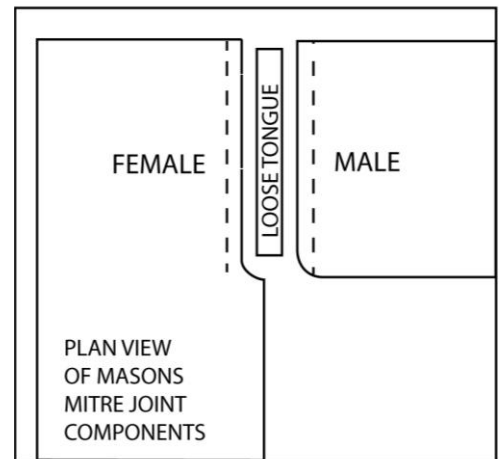


Fig. 15 Clean the seam

# Bonding the Joints

The range of Apollo Magna® Worktops are supplied with a colour coordinated Glue for bonding joints and edging strips. The Glue is supplied in 100ml Glue Cartridges that are designed to be used with a standard glue gun, each cartridge is sufficient for 2 full worktop joints and is supplied with 3 mixing nozzles – if there is more than 20 minutes between each use change to a new nozzle.

**Important:** Ensure that the glue cartridge fits flush against front of the glue gun and that the glue gun adapter (a large black plunger supplied in the glue Kit) fits squarely in the glue cartridge. Fit the mixing nozzle. **To ensure correct mixing and hardening discard the first small amount of extruded adhesive.**

# Bonding the Joints

Ensure that the work area is clean and dust free to avoid contamination of the glue which could lead to a visible joint line.

Place the worktops as close to their final installed position as possible to avoid unnecessary handling after the joint is bonded together.

## See fig. 16

Apply Apollo® Magna Glue to the top surfaces of the Loose Tongue, to the faces of the joint edge and to the inner edges of the front face material. Insert the loose tongues into the groove in one face of the joint.

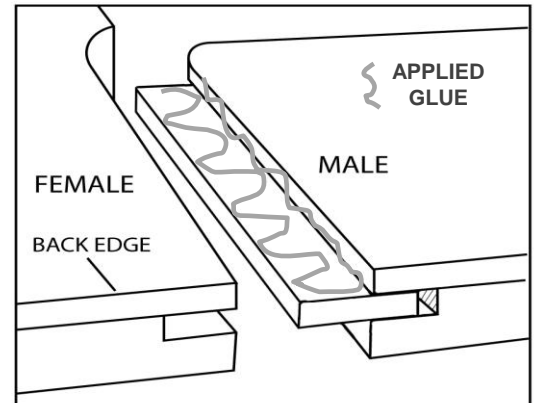
Push the two parts of the jointed worktops together leaving a small gap (2mm wide). Apply masking tape to the underside of the front edge of the worktop joint line to prevent the glue from dripping out onto the floor cabinets.

Apply a continuous bead of Glue to fill the gap into the joint line ensuring that sufficient Glue is used so that a continuous bead of Glue flows out of the joint line when the joint is clamped closed.

Apply pressure to close the joint with the G Clamps or Suction Cups, check for correct alignment and the top faces are flush and adjust before applying final pressure, check that a continuous bead of Glue has squeezed out of the joint line.

The Glue will cure to a hard consistency; this usually takes 30 to 40 minutes dependent upon the ambient temperature.

Fig. 16 Magna® Joint: Loose Tongue positioned in the joint and glue applied.



# Finishing the Joints

## Finishing the Seam (Joint Line): see Fig. 17

After the Glue has cured, remove the G clamps then, using a wide sharp chisel, remove the glue blocks and then the hot melt glue deposits – take care to keep the chisel flat to the top face to avoid digging into the surface.

## The Sanding Process: See Fig. 18

Generally the use of a Random Orbital Sander will cut faster and more efficiently with a finer finish than other methods, the use of Random Orbital Sander is therefore recommended. Care must be taken to avoid gouging the surface during this process.

Ensure that the sander is kept continually moving to prevent localised dips in the surface due to over sanding.

Use the sandpaper pads supplied in the Installation Kit in the correct order of 100grit, 150grit and finally of 220 or 240 grit in order to achieve the same results as the factory finish, blending approximately 600mm beyond the Seam Area to avoid patchiness. Take care to avoid the sandpaper becoming clogged with sanded material, this can lead to localised scratches which will require more work to remove before final finishing.

Complete the finishing process using the supplied abrasive pads in the correct order of Maroon Abrasive Pad, Grey Abrasive Pad and finally the white Abrasive Pad, the White Abrasive Pad should be on a dust free surface that has been wetted with the Stone guard Cleaner Spray.

## Note, Black and Dark finishes:

These colours are more likely than light colours to show slight differences in surface finish when first installed. To avoid this it may be necessary to apply the final finish process (described above) to the whole worktop installation rather than just around the joints.

These colours are more likely than light colours to show scratches and marks in high traffic areas (i.e. around hobs, sinks and the kettle), for this reason they require a more regular maintenance regime to retain the finish and to avoid patchiness.

## Note:

If a slightly matt surface is desired, the final finishing should be completed using the Grey Abrasive Pad and Stone Guard cleaning spray, however this is not recommended for black and dark finishes because the full depth of colour will not be achieved using this method.

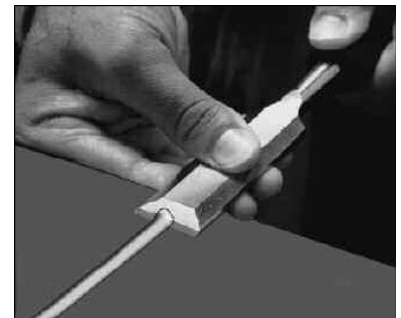


Fig. 17 Removing glue deposits



Fig. 18 Sanding using random Orbital sander

# Fixing the Worktops to the Floor Cabinets

**Magna® Worktops:** When the jointed and finished worktops are in the final position, they should be fixed in place using the Screws, Washers and Expansion Brackets provided in the Installation Kit.

Always use the supplied washers to screw through the slotted holes in the brackets into the worktop underside, this allows the worktops to naturally expand and contract; washers are not needed to screw the brackets into the floor cabinet sides. Fix the worktops to the floor cabinets at least every 600mm at the front and back of the cabinets.

The screws supplied or recommended are the correct size for this, they should only screw into the chipboard core and not screw into the 6mm Magna Solid Surface material; using the washers as described is very important because it allows the natural expansion and contraction movement of the worktop to occur without affecting the secure fixing.

If it is necessary or more convenient to fix the tops in place by screwing through the floor cabinet Front and/or Back Rails, longer screws are required (1" or 25mm No.6 Round Head Chipboard Screws- not supplied). Drill 6mm Diameter clearance holes through the Front and Rear Rails of the cabinets, always using the supplied washers, screw through the washer and the holes in the Rails into the chipboard core of the Magna worktops and directly into the Slab Tech worktop underside using pilot holes as above.

**Use this space to attach all Product Labels after the products are unpacked**

**Notes:**

---

---

---

---

---

## Care & Maintenance

**Important:** Please read the information carefully and ensure you keep these instructions for future reference.

Always refer to the Care & Maintenance video on [www.sheridan-uk.com](http://www.sheridan-uk.com).

Replacement Care & Maintenance products are available through [www.kitchenfittingsupplies.co.uk](http://www.kitchenfittingsupplies.co.uk).

### Looking after your Apollo Magna® Worktops

Apollo® Magna worksurfaces not only look very attractive and exude quality; they are designed to withstand the rigours of everyday use.

Upon installation an Apollo® Magna worksurface will have an overall satin sheen finish. However, through use, the worksurface acquires a smoother, more silken finish and appearance. Even the cleaning properties appear to improve with use. Unlike most other worksurfaces Apollo® Magna is 'repairable', so little accidents, stains or scratches can usually be removed with relative ease.

Your Installation & Maintenance Kit contains all of the items required to help keep your new worksurface in pristine condition.

**Stone Guard** is an anti-bactericidal surface cleaner specially formulated to tackle grease and grime leaving surfaces sparkling clean with a residual antibacterial effect.

**Cream Cleaner** is a renovating cream cleaner that will remove minor scratches and more stubborn stains from solid surface worktops.

**Important:** Please read and follow instructions carefully when using care & maintenance products. Always wear rubber gloves when using chemicals to prevent any cracking, drying or other reaction to your skin.

### Every day cleaning

Remember, it is always easier to wipe up a spill than to have to deal with a dried-on stain.

- Apollo® Magna worksurfaces are impervious to liquids however it is always best to clean up spills as they occur.
- Wipe the worksurface, with a damp cloth and the Stone Guard cleaner, (supplied in the Maintenance Kit), to remove any oils and fat. Buff dry with a soft white cloth (also in Kit).
- If any stains need further attention, allow the Stone Guard 30 seconds contact time, before wiping and rinsing. If required apply the Cream Cleaner with a damp cloth then the stone guard as above.
- If your worksurface has an integrated sink, clean this in the same way as the worksurface.
- Once a week after cleaning, fill the sink with warm, (not boiling), water; add 1-2 teaspoons (5-10ml), of liquid household bleach and leave to soak for a few hours, or overnight. This will help to maintain a beautiful white clean finish.

### Scratches

**Warning:** DO NOT cut or chop directly on the worksurface. Always use a chopping board.

- As with all work surfaces Apollo Magna® will show light abrasion marks in normal daily use.
- Darker coloured surfaces are more prone to minor scuffs and scratches than lighter options and will require more care and attention to keep them looking pristine.
- Most scratches can be removed with relative ease. Simply follow the same procedure as for removing persistent stains.
- If you are unsuccessful, contact the Helpline for further advice and assistance.

### Persistent stains

• To remove more persistent stains from the worksurface or integrated sink use the Abrasive Pads (White, Grey & Maroon), provided in the Kit.

• Always use the least abrasive pad possible to remove marks. Always rub in a circular motion.

• Start with the White Pad, rubbing the stain in a circular motion. If this is ineffective, progress to the more abrasive Grey Pad and finally the Maroon Pad.

• To remove any abrasion marks and to restore the worksurfaces former luster polish, use progressively less abrasive pads. Always finish by using the White Pad in conjunction with the Cream Cleaner and then the Stone Guard.

• If hard water scale has built up around the waste or taps, use a standard household lime-scale remover following the manufacturer's instructions. Try to avoid using an abrasive pad but if this is necessary, rinse well and polish as detailed above to restore the finish.

• For the most severe stains and scratches, it may be necessary to use the light grey sanding pad. Remove the scratch then follow the above process to restore the worksurface to its former finish. If this still fails contact us for further advice and assistance

### Other Spillages

• Accidental spills of strong chemicals, (e.g. paint stripper, brush cleaners, metal cleaners, oven cleaners, cleaners containing methylene chloride, acid drain cleaners, acetone based nail varnish removers etc.), should be washed away immediately using plenty of soapy water to avoid damaging the worksurface.

• For nail varnish spills, non-acetone based remover can be used and then flushed with water.

• Accidental spills of strong chemicals, (e.g. paint stripper, brush cleaners

### Damage Prevention

**Warning:** NEVER place hot pans, dishes or utensils directly on the worksurface or into an empty sink. Hot items will mark or damage the surface.

- Always use a heat protection pad or trivet (with rubber feet) for hot cookware, or leave cookware to cool on the hob first.
- Try to leave pans, dishes, or utensils to cool before placing them in the sink. If you must put a hot pan into the sink, always place a damp sponge or cloth underneath, or put a few inches of cool water in the sink before the pan.
- Avoid pouring boiling liquids directly into sinks without also turning on the cold tap.

### Hob Safety

The Installation & Maintenance Kit contains a heat reflective tape, which the installer should apply around the hob cutout in the worksurface, before fitting the hob. This will prevent any damage to the worksurface. However, extra care should be taken when using the hob. Please follow both the appliance manufacturer's instructions and the advice below:

- An overhanging pan can scorch the surrounding worksurface.
- Always use the correct size of pan for the burner and ensure that it is placed centrally.
- Do not use two burners as one (e.g. for a large griddle).
- Take extra care when using a large frying pan or wok.